

(19) World Intellectual Property Organization
International Bureau



(43) International Publication Date
12 January 2012 (12.01.2012)

(10) International Publication Number
WO 2012/006106 A2

- (51) International Patent Classification:
G06F 12/00 (2006.01) *G06F 11/10* (2006.01)
- (21) International Application Number:
PCT/US2011/042222
- (22) International Filing Date:
28 June 2011 (28.06.2011)
- (25) Filing Language: English
- (26) Publication Language: English
- (30) Priority Data:
12/825,858 29 June 2010 (29.06.2010) US
- (71) Applicant (for all designated States except US): INTEL CORPORATION [US/US]; 2200 Mission College Boulevard, Santa Clara, California 95052 (US).
- (72) Inventor; and
- (75) Inventor/Applicant (for US only): KHAN, Jawad B. [PK/US]; 826 N. 26th Avenue, Cornelius, Oregon 97113 (US).

- (74) Agents: VINCENT, Lester J. et al.; Blakely Sokoloff Taylor & Zafman, 1279 Oakmead Parkway, Sunnyvale, California 94085 (US).
- (81) Designated States (unless otherwise indicated, for every kind of national protection available): AE, AG, AL, AM, AO, AT, AU, AZ, BA, BB, BG, BH, BR, BW, BY, BZ, CA, CH, CL, CN, CO, CR, CU, CZ, DE, DK, DM, DO, DZ, EC, EE, EG, ES, FI, GB, GD, GE, GH, GM, GT, HN, HR, HU, ID, IL, IN, IS, JP, KE, KG, KM, KN, KP, KR, KZ, LA, LC, LK, LR, LS, LT, LU, LY, MA, MD, ME, MG, MK, MN, MW, MX, MY, MZ, NA, NG, NI, NO, NZ, OM, PE, PG, PH, PL, PT, RO, RS, RU, SC, SD, SE, SG, SK, SL, SM, ST, SV, SY, TH, TJ, TM, TN, TR, TT, TZ, UA, UG, US, UZ, VC, VN, ZA, ZM, ZW.
- (84) Designated States (unless otherwise indicated, for every kind of regional protection available): ARIPO (BW, GH, GM, KE, LR, LS, MW, MZ, NA, SD, SL, SZ, TZ, UG, ZM, ZW), Eurasian (AM, AZ, BY, KG, KZ, MD, RU, TJ, TM), European (AL, AT, BE, BG, CH, CY, CZ, DE, DK, EE, ES, FI, FR, GB, GR, HR, HU, IE, IS, IT, LT, LU, LV, MC, MK, MT, NL, NO, PL, PT, RO, RS, SE, SI, SK,

[Continued on next page]

(54) Title: METHOD AND SYSTEM TO IMPROVE THE PERFORMANCE AND/OR RELIABILITY OF A SOLID-STATE DRIVE

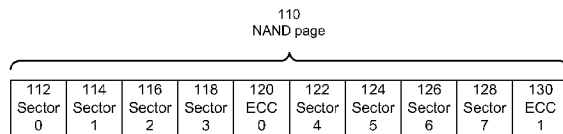

100 (PRIOR ART) FIG. 1A

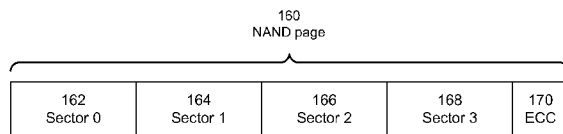

150 (PRIOR ART) FIG. 1B

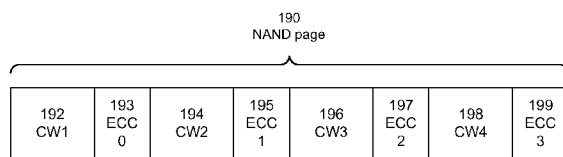

180 (PRIOR ART) FIG. 1C

(57) Abstract: A method and system to improve the performance and/or reliability of a solid-state drive (SSD). In one embodiment of the invention, the SSD has logic compress a block of data to be stored in the SSD. If it is not possible to compress the block of data below the threshold, the SSD stores the block of data without any compression. If it is possible to compress the block of data below the threshold, the SSD compresses the block of data and stores the compressed data in the SSD. In one embodiment of the invention, the SSD has logic to dynamically adjust or select the strength of the error correcting code of the data that is stored in the SSD. In another embodiment of the invention, the SSD has logic to provide intra-page XOR protection of the data in the page.



WO 2012/006106 A2

SM, TR), OAPI (BF, BJ, CF, CG, CI, CM, GA, GN, GQ, GW, ML, MR, NE, SN, TD, TG). **Published:**

— *without international search report and to be republished upon receipt of that report (Rule 48.2(g))*

**METHOD AND SYSTEM TO IMPROVE THE PERFORMANCE AND/OR
RELIABILITY OF A SOLID-STATE DRIVE**
FIELD OF THE INVENTION

This invention relates to a solid-state drive, and more specifically but not
5 exclusively, to a method and system to improve the performance and/or reliability
of the solid-state drive.

BACKGROUND DESCRIPTION

Error protection mechanisms are often used to ensure the integrity of the
data stored in a solid-state drive. Figure 1A illustrates a block diagram **100** of data
10 stored in a prior art NAND flash memory page **110**. The prior art NAND flash
memory page **110** has sector 0 **112**, sector 1 **114**, sector 2 **116**, and sector 3 **118**
that are protected by the Error Correcting Code 0 (ECC 0) check bytes **120**.
Similarly, the ECC 1 check bytes **130** protects the sector 4 **122**, sector 5 **124**,
sector 6 **126**, and sector 7 **128** of the prior art NAND flash memory page **110**.

15 Depending on the severity of the errors in each sector, the ECC 0 check
bytes **120** and ECC 1 check bytes **130** can facilitate the detection of errors in the
sectors and allow data recovery of the error(s) in the sectors. Figure 1B illustrates
a block diagram **150** of the data stored in a prior art NAND flash memory page
160. The prior art NAND flash memory page **160** has the sector 0 **162**, sector 1
20 **164**, sector 2 **166**, and sector 3 **168** that are protected by the ECC check bytes
170. Figure 1C illustrates a block diagram **180** of the code words stored in a prior
art NAND flash memory page **190**. The prior art NAND flash memory page **190**
has four code words (CW) 1-4 **192**, **194**, **196**, and **198** that are protected by the
ECC 0-3 check bytes **193**, **195**, **197**, and **199** respectively.

25 BRIEF DESCRIPTION OF THE DRAWINGS

The features and advantages of embodiments of the invention will become
apparent from the following detailed description of the subject matter in which:

Figure 1A illustrates a block diagram of data stored in a prior art NAND
flash memory page;

30 Figure 1B illustrates a block diagram of data stored in a prior art NAND
flash memory page;

Figure 1C illustrates a block diagram of code words stored in a prior art
NAND flash memory page;

Figure 2 illustrates a block diagram of a solid-state drive in accordance with one embodiment of the invention;

Figure 3A illustrates a block diagram of a controller in accordance with one embodiment of the invention;

5 Figure 3B illustrates a block diagram of a controller in accordance with one embodiment of the invention;

Figure 4 illustrates a block diagram of compressed data stored in a NAND flash memory in accordance with one embodiment of the invention;

10 Figure 5 illustrates a block diagram of compressed data stored in a NAND flash memory in accordance with one embodiment of the invention;

Figure 6 illustrates a block diagram of a compressed sector and a known data pad in accordance with one embodiment of the invention;

Figure 7 illustrates a block diagram of two NAND flash memory pages in accordance with one embodiment of the invention;

15 Figure 8 illustrates a block diagram of a NAND flash memory page in accordance with one embodiment of the invention;

Figure 9 illustrates a block diagram of a NAND flash memory page in accordance with one embodiment of the invention; and

20 Figure 10 illustrates a system to implement the methods disclosed herein in accordance with one embodiment of the invention.

DETAILED DESCRIPTION

Embodiments of the invention described herein are illustrated by way of example and not by way of limitation in the accompanying figures. For simplicity and clarity of illustration, elements illustrated in the figures are not necessarily drawn to scale. For example, the dimensions of some elements may be exaggerated relative to other elements for clarity. Further, where considered appropriate, reference numerals have been repeated among the figures to indicate corresponding or analogous elements. Reference in the specification to “one embodiment” or “an embodiment” of the invention means that a particular feature, structure, or characteristic described in connection with the embodiment is included in at least one embodiment of the invention. Thus, the appearances of the phrase “in one embodiment” in various places throughout the specification are not necessarily all referring to the same embodiment.

25
30

An Error Correcting or Correction code (ECC) allows data that is being read or transmitted to be checked for errors and corrected when needed. The ECC check bytes are a sequence of bits that are calculated based on an ECC algorithm that allows the detection and correction of the data. A code word refers to a combination of payload data and ECC check bytes in one embodiment of the invention. A data chunk of data is a block or partition of data that is read or written for each operation.

Embodiments of the invention provide a method and system to improve the performance and/or reliability of a solid-state drive (SSD). In one embodiment of the invention, the SSD has logic to compress a block of data that is to be stored in the SSD and determine whether the block of data to be stored in the SSD is compressed below a threshold. If it is not possible to compress the block of data below the threshold, the SSD stores the block of data without any compression. If it is possible to compress the block of data below the threshold, the SSD stores the compressed data in the SSD.

The performance of the SSD is linked to the amount of excess memory that is reserved for managing the SSD and the extra space gained by compressing the block of data is used to improve the performance of the SSD in one embodiment of the invention. In one embodiment of the invention, the amount of excess memory and/or the extra space gained by compressing the block of data is not reported and is not available to a user of the SSD. In one embodiment of the invention, the SSD uses, but is not limited to, NAND flash memory modules and any other form of memory storage medium. In one embodiment of the invention, the SSD is compliant at least in part with an Open NAND Flash Interface (ONFI) protocol.

In one embodiment of the invention, the SSD has logic to dynamically adjust or select the strength of the error correcting code (ECC) of the data that is stored in the SSD. The SSD dynamically adjusts the strength of the ECC of the data by compressing the data and appending or adding a known data pad in one embodiment of the invention. The ECC of the compressed data and the known data pad is determined or calculated and the ECC check bytes are stored in addition to the compressed data and the known data pad. The known data pad

has a sequence of data or information that is pre-set or pre-determined to facilitate the recovery of the errors in the compressed data.

In another embodiment of the invention, the data is partitioned or divided into a number of code words or data chunks. In one embodiment of the invention, the SSD selects one of the code words and performs an exclusive OR (XOR) operation on all the code words except the selected code word to obtain a XOR code word. The SSD replaces the selected code word with the XOR code word. In one embodiment of the invention, the SSD stores the XOR code word and the other code words in a single memory page. This allows an intra-page recovery to be performed if there is an error in any one of the code words in the single memory page.

Figure 2 illustrates a block diagram **200** of a SSD **202** in accordance with one embodiment of the invention. The SSD **102** has a controller **230** that is coupled with a host interface module **210**, a buffer **220**, memory module **0** **240**, memory module **1** **242**, memory module **2** **244**, and memory module **3** **246**.

In one embodiment of the invention, the host interface module **210** provides an interface to connect with a host device or system. The host interface module **210** operates in accordance with a communication protocol, including but not limited to, Serial Advanced Technology Attachment (SATA) Revision 1.x, SATA Revision 2.x, SATA Revision 3.x, and any other type of communication protocol.

The buffer **220** provides temporary storage to the SSD **202** in one embodiment of the invention. The buffer **220** includes, but is not limited to, Synchronous Dynamic Random Access Memory (SDRAM), Dynamic Random Access Memory (DRAM), RAMBUS Dynamic Random Access Memory (RDRAM), Static RAM (SRAM), and/or any other type of random access memory device. In one embodiment of the invention, the buffer **220** is integrated within the controller **230**.

The controller **230** has logic to dynamically adjust or select the strength of the error correcting code (ECC) of the data that is stored in the memory modules **0-3** **240**, **242**, **244**, and **246** in one embodiment of the invention. The controller **230** also has logic to compress a block of data to be stored in the memory modules **0-3** **240**, **242**, **244**, and **246** and determine whether the block of data to

be stored in the memory modules 0-3 **240**, **242**, **244**, and **246** is compressed below a threshold in one embodiment of the invention.

In one embodiment of the invention, the memory modules 0-3 **240**, **242**, **244**, and **246** include, but are not limited to, NAND flash memories and the like.

5 The number of memory modules shown in figure 2 is not meant to be limiting and in other embodiments of the invention, there can be more or less than four memory modules. In one embodiment of the invention, the controller **230**, the host interface module **210** and the buffer **220** are integrated into a single integrated circuit (ASIC).

10 Figure 3A illustrates a block diagram **300** of a controller **230** in accordance with one embodiment of the invention. For clarity of illustration, figure 3A is discussed with reference to figure 2. In one embodiment of the invention, the controller **230** has a multiplexer **320** that has an input from the raw data **305** and an input from the compression engine **310**. The data selector **325** provides the selection signal between the raw data **305** and the
15 compression engine **310** to the multiplexer **320**. The output of the multiplexer **320** is coupled with an encryption / scrambling module **330** and the output of the encryption / scrambling module **330** is coupled with a memory controller **340**. The memory controller is coupled with the memory modules 0-3 **240**,
20 **242**, **244**, and **246** in one embodiment of the invention.

In one embodiment of the invention, the compression engine **310** is capable of compressing the raw data **305** that comes from the host interface module **210** and/or the buffer **220**. As the raw data **305** arrives, the compression engine **310** compresses each block of raw data **305**. When a block of raw data
25 **305** is determined to be compressible below a particular threshold, the compression engine **310** informs the data selector **325** to send a signal to the multiplexer **320** to select the input from the compression engine **310** to receive the compressed block of raw data **305** that is determined to be compressible below the particular threshold.

30 When a block of raw data **305** is determined not to be compressible below the particular threshold, the compression engine **310** informs the data selector **325** to send a signal to the multiplexer **320** to select the input from the raw data **305**. The controller **230** allows the raw data **305** to be stored in compressed form

or format only when the amount of achievable compression exceeds the threshold in one embodiment of the invention.

The size of the block of raw data **305** is set at, but is not limited to, 512 bytes, 1 kilobytes, and any other appropriate size suitable for compression. The
5 threshold is set at, but is not limited to, a size of the compressed block of data, a compression ratio of a size of the block of data to a size of the compressed block of data, and any other suitable indicator of the compression. In one embodiment of the invention, the data selector **325** and the compression engine **310** are combined together into a single module. The compression engine **310** is a
10 hardware based compression engine that uses a lossless data compression algorithm in one embodiment of the invention. This allows the original data from the raw data **305** to be reconstructed from the compressed data during the decompression phase. The lossless data compression algorithm includes, but is not limited to, the Lempel-Ziv (LZ) class of lossless data compression algorithms
15 including but not limited to LZ77, LZ78, LZSS, LZW and their variants, and any other suitable universal lossless data compression algorithms now known or discovered in future.

The encryption / scrambling module **330** encrypts and/or scrambles the output from the multiplexer **320** and sends the encrypted and/or scrambled output
20 to the memory controller **340**. In one embodiment of the invention, the memory controller **340** writes the encrypted and/or scrambled output to the memory modules 0-3 **240**, **242**, **244**, and **246**. In another embodiment of the invention, the memory controller **340** can optionally group the compressed blocks of raw data and write to the memory modules 0-3 **240**, **242**, **244**, and **246** as a contiguous
25 memory page. The size of the memory page is set at, but is not limited to, 4 kilobytes or any other suitable size. In another embodiment of the invention, the memory controller **340** writes the compressed blocks of raw data back to the buffer **220** and then issues a write command or operation to write the compressed blocks of raw data from the buffer **220** to the memory modules 0-3 **240**, **242**, **244**,
30 and **246** directly.

In one embodiment of the invention, the memory controller **340** keeps track of the compression status of each block of data written to the memory modules 0-3 **240**, **242**, **244**, and **246**. The memory controller **340** keeps track of the

compression status of a particular block of data by setting a token associated with that particular block of data to indicate whether that particular block of data has been compressed. The token includes but is not limited to one or more bits. In one embodiment of the invention, the token has 32 bits that are used to determine
5 whether a particular block of data is compressed or not.

For example, in one embodiment of the invention, the memory controller **340** writes a bit in a token for each block of data written to the memory modules 0-3 **240, 242, 244, and 246**. The bit in the token associated with any block of data is set to logic one if the block of data has been compressed and is set to logic
10 zero if the block of data has not been compressed. One of ordinary skill in the relevant will readily appreciate that other methods of tracking the compression status of the blocks of data can be used without affecting the workings of the invention.

Figure 3B illustrates a block diagram **360** of a controller **230** in
15 accordance with one embodiment of the invention. For clarity of illustration, figure 3B is discussed with reference to figures 2 and 3A. In one embodiment of the invention, the controller **230** has a memory controller **340** that receives data from the memory modules 0-3 **240, 242, 244, and 246**. The memory controller **340** sends the received data to a decryption / descrambling module
20 **370**.

The decryption / descrambling module **370** decrypts and/or descrambles the received data from the memory controller **340** and sends the decrypted and/or descrambled data to the decompression engine **380** and the multiplexer **390**. The decompression engine **380** uses the same lossless data decompression algorithm
25 as the compression engine **310** in one embodiment of the invention.

The data selector **385** reads the token **384** associated with the received data to determine whether the received data has been compressed. If the token associated with the received data indicates that the received data has been compressed, the data selector **385** sends a signal to the decompression engine
30 **380** to decompress the received data and sends a signal to multiplexer **390** to select the output from the decompression engine **380** as the data to be sent to the host interface module **210** and/or buffer **220**.

If the token **384** associated with the received data indicates that the received data has not been compressed, the data selector **385** does not send a signal to the decompression engine **380** to decompress the received data and sends a signal to multiplexer **390** to select the output from the decryption /
5 descrambling module **370** as the data to be sent to the host interface module **210** and/or buffer **220**. In one embodiment of the invention, the data selector **385** and the multiplexer **390** are integrated within the decompression engine **380**. The configuration of the controller **230** illustrated in figures 3A and 3B is not meant to be limiting and other variation of the configuration of the controller **230** can be
10 done without affecting the workings of the invention.

Figure 4 illustrates a block diagram **400** of compressed data stored in a NAND flash memory in accordance with one embodiment of the invention. For clarity of illustration, figure 4 is discussed with reference to figures 1A and 3A. In one embodiment of the invention, the controller **230** receives the sectors 0-7 **112**,
15 **114**, **116**, **118**, **122**, **124**, **126**, and **128** as the raw data **305** from a host that are to be stored in the memory modules 0-3 **240**, **242**, **244**, and **246**. In one embodiment of the invention, the compression engine **310** reads four data sectors as a single block of data, i.e., the sectors 0-3 **112**, **114**, **116**, and **118** are read as a single block of data and the sectors 4-7 **122**, **124**, **126**, and **128** are read as another
20 single block of data.

The compression engine **310** compresses the block of data made up of the sectors 0-3 **112**, **114**, **116**, and **118** and determines whether the block of data is compressed below a threshold. Assuming that the block of data made up of the sectors 0-3 **112**, **114**, **116**, and **118** is compressed below the threshold, the data
25 selector **325** sends a signal to the multiplexer **320** to select the compressed sectors 0-3 **112**, **114**, **116**, and **118** as the input to the multiplexer **320**.

The compressed sectors 0-3 **112**, **114**, **116**, and **118** are encrypted and/or scrambled by the encryption / scrambling module **330** if needed and the memory controller **340** writes the compressed sectors 0-3 **112**, **114**, **116**, and **118** to a
30 NAND flash memory as the compressed sectors 0-3 **412** in one embodiment of the invention. The memory controller **340** uses an ECC algorithm to calculate the ECC check bytes of the compressed sectors 0-3 **412** and writes the calculated ECC check bytes as the ECC 0 check bytes **420** in the NAND flash memory. The

ECC algorithm includes, but is not limited to, a Hamming algorithm, a Reed-Solomon algorithm, a Bose-Chaudhuri-Hocquenghem (BCH) algorithm, Low density parity check (LDPC) codes and the like.

The compressed sectors 4-7 **422** and the ECC 1 check bytes **430** are
5 generated in a similar manner as the compressed sectors 0-3 **412** and the ECC 0
check bytes **420** and shall not be described herein. One of ordinary skill in the
relevant art will readily appreciate how the compressed sectors 4-7 **422** and the
ECC 1 check bytes **430** are generated.

By compressing the sectors 0-3 **112**, **114**, **116**, and **118** and the sectors 4-7
10 **122**, **124**, **126**, and **128**, less memory space is required and the extra spare area
432 illustrates the memory area that is saved in the NAND flash memory. In one
embodiment of the invention, the extra spare area **432** can be used to increase
the performance of the SSD **202**. The performance of the SSD **202** is increased
as it requires less power to write the compressed sectors 0-3 **412** and sectors 4-7
15 **422** and the memory bandwidth of the SSD **202** is increased in one embodiment
of the invention. In addition, the performance of the SSD **202** is increased as the
write amplification of the SSD **202**, i.e., the extra write operations to write a block
of data, is reduced as lesser memory area is required to store the compressed
sectors 0-3 **412** and sectors 4-7 **422**. In addition, the performance of the SSD **202**
20 is also increased because a larger shuffle area becomes available and the SSD
202 does not have to move data around to create shuffle area in order to be able
to continue writing to the memory modules 0-3 **240**, **242**, **244**, and **246**.

Figure 5 illustrates a block diagram **500** of compressed data stored in a
NAND flash memory in accordance with one embodiment of the invention. In one
25 embodiment of the invention, the memory controller **340** uses an ECC algorithm to
calculate the ECC check bytes of both compressed sectors 0-3 **512** and sectors 4-
7 **522** and writes the calculated ECC check bytes as the ECC check bytes **530** in
the NAND flash memory. The extra spare area **540** illustrates the memory area
that is saved in the NAND flash memory. In one embodiment of the invention, the
30 memory controller **340** writes other compressed or uncompressed sectors in the
extra spare area **540**.

Figure 6 illustrates a block diagram **600** of the compressed sectors 0-3 **612**
and a known data pad **622** in accordance with one embodiment of the invention.

For clarity of illustration, figure 6 is discussed with reference to figures 1B and 3A. The sectors 0-3 **162**, **164**, **166**, and **168** of the prior art NAND flash memory page **160** are compressed and stored as the compressed sectors 0-3 **612** in one embodiment of the invention. The size of the uncompressed sectors 0-3 **610** illustrates the size required to store the sectors 0-3 **162**, **164**, **166**, and **168** of the prior art NAND flash memory page **160**.

When the sectors 0-3 **162**, **164**, **166**, and **168** of the prior art NAND flash memory page **160** are compressed, it creates an extra spare area **620**. In one embodiment of the invention, the extra space area **620** is filled with a known data pad **622**. For example, in one embodiment of the invention, the known data pad **622** has a repeating sequence or pattern of information and/or data. In one embodiment of the invention, the known data pad **622** is a repeating sequence of 1011b. One of ordinary skill in the relevant art will readily appreciate that other sequences of data can be used as the known data pad without affecting the workings of the invention.

The memory controller **340** calculates the ECC of the compressed sectors 0-3 **612** and the known data pad **622** and adds the calculated ECC check bytes as the ECC check bytes **630**. By appending or adding the known data pad **622** to the compressed sectors 0-3 **612**, the strength of the ECC check bytes **630** is more than the strength of the ECC 0 check bytes **170** of the prior art NAND flash memory page **160** in one embodiment of the invention. This is because the ECC check bytes **630** are effectively protecting a smaller payload size of the compressed sectors 0-3 **612** and the known data pad **622** allows errors to be fixed by inspection and therefore, the ECC check bytes **630** are strengthened.

In one embodiment of the invention, the SSD **202** dynamically adjusts or selects the strength of the error correcting code (ECC) of the data that is stored in the memory modules 0-3 **240**, **242**, **244**, and **246** by adjusting the size of the known data pad **622**. The size of the known data pad **622** is variable and depends on the compression ratio of the sectors 0-3 **162**, **164**, **166**, and **168** achieved. In one embodiment of the invention, the SSD **202** dynamically adjusts the strength of the ECC of the block of data based on the bit error rate (BER) associated with a location in a memory module that is to store the block of data. The location in the

memory module includes, but is not limited to, word lines in the memory module and any other form of memory allocation or distribution in the memory module.

For example, in one embodiment of the invention, the BER associated with the word line may be increasing with the order of the word line of the memory module, i.e, a higher order word line may have a worst BER than a lower order word line. In one embodiment of the invention, the SSD **202** actively matches the ECC strength of any data or code word based on the BER characteristics of any memory location where the data or code word is to be stored. In one embodiment of the invention, the SSD **202** uses a stronger ECC for data that is stored in the higher order word lines and a weaker ECC for data that is stored in the lower order word lines. In this way, the SSD **202** does not need to use a common strength of ECC that is suited for the worst scenario of BER and can use a flexible ECC selection scheme to increase the reliability of the SSD **202** in one embodiment of the invention.

In another embodiment of the invention, the number of erase operations performed on any physical band or region of the memory modules **0-3 240, 242, 244** and **266** is tracked by the SSD **202**. In one embodiment of the invention, the SSD **202** actively matches the ECC strength of any data or code word based on the erase count of the particular memory location where the data or code word is to be stored. For example, in one embodiment of the invention, the SSD **202** uses a stronger ECC strength for data that is to be stored in a memory location that has a higher erase count and uses a weaker ECC strength for data that is to be stored in a memory location that has a lower erase count. One of ordinary skill in the relevant art will readily appreciate that other factors can be used to determine the required strength of the ECC of the data and these other factors can be used without affecting the workings of the invention.

Figure 7 illustrates a block diagram **700** of two NAND flash memory pages **710** and **760** in accordance with one embodiment of the invention. For clarity of illustration, figure 7 is discussed with reference to figure 1B. The NAND flash memory pages **710** and **760** illustrate two different embodiments of the compressed data sectors **0-3** formed by compressing the sectors **0-3 112, 114, 116,** and **118** of the prior art NAND flash memory page **160**. The NAND flash memory page **710** illustrates that the compressed data sectors **0-3** are partitioned

into two code words, i.e., the compressed sectors 0-3 (code word 1) **712** and the compressed sectors 0-3 (code word 2) **722**.

The code word 1 **712** and code word 2 **722** have an ECC 0 check bytes **720** and ECC 1 check bytes **730** respectively in one embodiment of the invention.

5 Compared to the prior art NAND flash memory page **160**, the NAND flash memory page **710** has a stronger ECC strength in one embodiment of the invention. This is because the ECC check bytes **170** of the prior art NAND flash memory page **160** is protecting the uncompressed sectors 0 to 3, **162**, **164**, **166**, and **170** that have a larger number of bits. Each of the ECC 0 check bytes **720** and the ECC 1 check bytes **730** of the NAND flash memory page **710** are protecting a code word of the

10 compressed data sectors 0-3 that have a smaller number of bits.

The NAND flash memory page **760** illustrates that the compressed data sectors 0-3 are partitioned into four code words, i.e., the compressed sectors 0-3 (code word 1) **772**, the compressed sectors 0-3 (code word 2) **774**, the compressed sectors 0-3 (code word 3) **776** and the compressed sectors 0-3 (code word 4) **778**. The code words 1-4 **772**, **774**, **776** and **778** have an ECC 0-3 check bytes **780**, **782**, **784**, and **786** respectively in one embodiment of the invention. Compared to the prior art NAND flash memory page **160**, the NAND flash memory page **760** has a stronger ECC strength in one embodiment of the

15 invention as each of the ECC 0-3 check bytes **780**, **782**, **784**, and **786** are protecting a smaller data chunk.

The NAND flash memory pages **710** and **760** illustrate how the SSD **202** dynamically adjusts or selects the strength of the error correcting code (ECC) of the data that is stored in the memory modules 0-3 **240**, **242**, **244**, and **246** by adjusting the number of partitions or divisions of the compressed data, i.e., adjusting the number of code words in one embodiment of the invention. For example, in one embodiment of the invention, if a stronger ECC strength is desired, a compression algorithm that can achieve a higher compression ratio can be selected to increase the extra spare area arising from the compression. The

25 extra spare area accommodates a higher number of code words and ECC check bytes which increases the effective ECC strength of the compressed data.

Figure 8 illustrates a block diagram **800** of a NAND flash memory page **810** in accordance with one embodiment of the invention. For clarity of illustration,

figure 8 is discussed with reference to figure 1B. In one embodiment of the invention, the uncompressed sectors 0 to 3, **162**, **164**, **166**, and **170** of the prior art NAND flash memory page **160** are compressed and partitioned into two code words, i.e., the compressed sectors 0-3 (code word 1) **812** and the compressed sectors 0-3 (code word 2) **822**.

In one embodiment of the invention, each of the code words **812** and **822** is appended with the known data pads **814** and **824** respectively. In one embodiment of the invention, the known data pads **814** and **824** have the same known or pre-set data. In other embodiments of the invention, the known data pads **814** and **824** have different known or pre-set data. The ECC of the code words **812** and the known data pad **814** is calculated and the calculated ECC is added as the ECC 0 check bytes **820**. Similarly, the ECC of the code words **822** and the known data pad **824** is calculated and the calculated ECC is added as the ECC 1 check bytes **830**.

The NAND flash memory page **810** illustrates how the SSD **202** dynamically adjusts or selects the strength of the error correcting code (ECC) of the data that is stored in the memory modules 0-3 **240**, **242**, **244**, and **246** by adjusting the number of partitions of the compressed data. The number of sectors and the number of known data pads illustrate in figure 8 is not meant to be limiting and other configuration of the number of sectors and known data pads can be used without affecting the workings of the invention.

Figure 9 illustrates a block diagram **910** of a NAND flash memory page **910** in accordance with one embodiment of the invention. For clarity of illustration, figure 9 is discussed with reference to figure 1C. In one embodiment of the invention, an exclusive OR (XOR) operation is performed on the code word 1 **192**, the code word 2 **194**, and the code word 3 **196** to obtain a XOR code word **920**. The XOR code word is stored in place of the code word 4 **198** in the NAND flash memory page **910**. The ECC of the XOR code word **920** is calculated and the calculated ECC is added as the ECC 3 check bytes **926**.

In one embodiment of the invention, the NAND flash memory page **910** with the XOR protection allows a single read operation of the NAND flash memory page **910** to recover from an uncorrectable ECC error. When the SSD **202** experiences a fatal or unrecoverable error in one of the code words 1-3 **192**, **194**

and **196**, the SSD **202** can use the XOR code word **920** to regenerate the code word with the fatal error in one embodiment of the invention. The SSD **202** can recover from the fatal error in the code word by reading the single NAND flash memory page **910**, i.e., intra-page XOR protection, in one embodiment of the invention.

The selection of the last code word **4 198** to be replaced by the XOR code word **920** is not meant to be limiting. In other embodiments of the invention, a different code word is selected to be replaced by an XOR code word. For example, in one embodiment of the invention, the code word **2 194** is selected to be replaced by a XOR code word that is obtained from an XOR operation of the code word **1 192**, the code word **3 196** and the code word **4 198**. In one embodiment of the invention, the XOR protection in the NAND page **910** is performed when the compression of the uncompressed sectors **0 to 3, 162, 164, 166, and 170** of the prior art NAND flash memory page **160** gains an extra spare area that can accommodate the size of one or more code words.

The techniques described herein allow the SSD **202** to increase its performance and the extra spare area obtained through the compression does not incur any associated cost of NAND area. In one embodiment of the invention, the threshold based compression technique simplifies the book keeping functions of the SSD **202** by reducing the granularity needed for tracking the state of any given block.

Figure 10 illustrates a system **1000** to implement the methods disclosed herein in accordance with one embodiment of the invention. The system **1000** includes, but is not limited to, a desktop computer, a laptop computer, a netbook, a notebook computer, a personal digital assistant (PDA), a server, a workstation, a cellular telephone, a mobile computing device, an Internet appliance or any other type of computing device. In another embodiment, the system **1000** used to implement the methods disclosed herein may be a system on a chip (SOC) system.

The processor **1010** has a processing core **1012** to execute instructions of the system **1000**. The processing core **1012** includes, but is not limited to, pre-fetch logic to fetch instructions, decode logic to decode the instructions, execution logic to execute instructions and the like. The processor **1010** has a cache

memory **1016** to cache instructions and/or data of the system **1000**. In another embodiment of the invention, the cache memory **1016** includes, but is not limited to, level one, level two and level three, cache memory or any other configuration of the cache memory within the processor **1010**.

5 The memory control hub (MCH) **1014** performs functions that enable the processor **1010** to access and communicate with a memory **1030** that includes a volatile memory **1032** and/or a non-volatile memory **1034**. The volatile memory **1032** includes, but is not limited to, Synchronous Dynamic Random Access Memory (SDRAM), Dynamic Random Access Memory (DRAM), RAMBUS
10 Dynamic Random Access Memory (RDRAM), and/or any other type of random access memory device. The non-volatile memory **1034** includes, but is not limited to, NAND flash memory, phase change memory (PCM), read only memory (ROM), electrically erasable programmable read only memory (EEPROM), or any other type of non-volatile memory device.

15 The memory **1030** stores information and instructions to be executed by the processor **1010**. The memory **1030** may also stores temporary variables or other intermediate information while the processor **1010** is executing instructions. The chipset **1020** connects with the processor **1010** via Point-to-Point (PtP) interfaces **1017** and **1022**. The chipset **1020** enables the processor **1010** to
20 connect to other modules in the system **1000**. In one embodiment of the invention, the interfaces **1017** and **1022** operate in accordance with a PtP communication protocol such as the Intel® QuickPath Interconnect (QPI) or the like. The chipset **1020** connects to a display device **1040** that includes, but is not limited to, liquid crystal display (LCD), cathode ray tube (CRT) display, or any other form of visual
25 display device.

 In addition, the chipset **1020** connects to one or more buses **1050** and **1055** that interconnect the various modules **1074**, **1060**, **1062**, **1064**, and **1066**. Buses **1050** and **1055** may be interconnected together via a bus bridge **1072** if there is a mismatch in bus speed or communication protocol. The chipset **1020**
30 couples with, but is not limited to, a non-volatile memory **1060**, the SSD **202**, a keyboard/mouse **1064** and a network interface **1066**. The chipset may also include a mass storage device that includes, but is not limited to, a hard disk drive,

an universal serial bus flash memory drive, or any other form of computer data storage medium.

The network interface **1066** is implemented using any type of well known network interface standard including, but not limited to, an Ethernet interface, a
5 universal serial bus (USB) interface, a Peripheral Component Interconnect (PCI) Express interface, a wireless interface and/or any other suitable type of interface. The wireless interface operates in accordance with, but is not limited to, the IEEE 802.11 standard and its related family, Home Plug AV (HPAV), Ultra Wide Band (UWB), Bluetooth, WiMax, or any form of wireless communication protocol.

10 While the modules shown in Figure 10 are depicted as separate blocks within the system **1000**, the functions performed by some of these blocks may be integrated within a single semiconductor circuit or may be implemented using two or more separate integrated circuits. For example, although the cache memory **1016** is depicted as a separate block within the processor **1010**, the cache
15 memory **1016** can be incorporated into the processor core **1012** respectively. The system **1000** may include more than one processor / processing core in another embodiment of the invention.

The methods disclosed herein can be implemented in hardware, software, firmware, or any other combination thereof. Although examples of the
20 embodiments of the disclosed subject matter are described, one of ordinary skill in the relevant art will readily appreciate that many other methods of implementing the disclosed subject matter may alternatively be used. In the preceding description, various aspects of the disclosed subject matter have been described. For purposes of explanation, specific numbers, systems and configurations were
25 set forth in order to provide a thorough understanding of the subject matter. However, it is apparent to one skilled in the relevant art having the benefit of this disclosure that the subject matter may be practiced without the specific details. In other instances, well-known features, components, or modules were omitted, simplified, combined, or split in order not to obscure the disclosed subject matter.

30 The term "is operable" used herein means that the device, system, protocol etc, is able to operate or is adapted to operate for its desired functionality when the device or system is in off-powered state. Various embodiments of the disclosed subject matter may be implemented in hardware, firmware, software, or

combination thereof, and may be described by reference to or in conjunction with program code, such as instructions, functions, procedures, data structures, logic, application programs, design representations or formats for simulation, emulation, and fabrication of a design, which when accessed by a machine results in the machine performing tasks, defining abstract data types or low-level hardware contexts, or producing a result.

The techniques shown in the figures can be implemented using code and data stored and executed on one or more computing devices such as general purpose computers or computing devices. Such computing devices store and communicate (internally and with other computing devices over a network) code and data using machine-readable media, such as machine readable storage media (e.g., magnetic disks; optical disks; random access memory; read only memory; flash memory devices; phase-change memory) and machine readable communication media (e.g., electrical, optical, acoustical or other form of propagated signals – such as carrier waves, infrared signals, digital signals, etc.).

While the disclosed subject matter has been described with reference to illustrative embodiments, this description is not intended to be construed in a limiting sense. Various modifications of the illustrative embodiments, as well as other embodiments of the subject matter, which are apparent to persons skilled in the art to which the disclosed subject matter pertains are deemed to lie within the scope of the disclosed subject matter.

CLAIMS

What is claimed is:

1. An apparatus comprising:
logic to:
 - 5 compress a block of data;
determine whether the block of data is compressed below a
threshold; and
write the compressed block of data into one or more memory
modules in response to a determination that the block of data is compressed
10 below the threshold.
 2. The apparatus of claim 1, wherein the logic is further to write the block of
data into one or more memory modules without compression in response to a
determination that the block of data is not compressed below the threshold.
 3. The apparatus of claim 1, wherein the threshold is based on at least one of
15 a size of the compressed block of data, and a ratio of a size of the block of data to
a size of the compressed block of data.
 4. The apparatus of claim 1, wherein the logic is further to dynamically adjust
a strength of an Error Correcting Code (ECC) of the block of data.
 5. The apparatus of claim 4, wherein the logic to dynamically adjust the
20 strength of the ECC of the block of data is to dynamically adjust the strength of the
ECC of the block of data based on at least one of a Bit Error rate (BER)
associated with a location in the one or more memory modules that is to store the
block of data and an erase count of a physical region that is to store the block of
data.
 - 25 6. The apparatus of claim 4, wherein the logic to dynamically adjust the
strength of the ECC of the block of data is to:
 - append a known data pad to the compressed block of data, wherein a
combined size of the known data pad and the compressed block of data is to
match a size of the block of data;
 - 30 determine ECC check bytes of the compressed block of data and the
known data pad; and
append the determined ECC check bytes to the compressed block of data
and the known data pad.

7. The apparatus of claim 4, wherein the compressed block of data comprises a plurality of code words and wherein the logic to dynamically adjust the strength of the ECC of the block of data is to:

5 determine a respective one of a plurality of ECC check bytes for each of the plurality of code words; and
append the determined respective one ECC check bytes to each of the plurality of code words.

8. The apparatus of claim 4, wherein the compressed block of data comprises a plurality of code words and wherein the logic to dynamically adjust the strength
10 of the ECC of the block of data is to:

append a respective one of a plurality of known data pads to each of the plurality of code words;
determine a respective one of a plurality of ECC check bytes for each of the plurality of code words and each respective one of the plurality of known data
15 pads; and
append the determined respective one ECC check bytes to each code word and each respective one known data pad.

9. The apparatus of claim 4, wherein the compressed block of data comprises a plurality of code words and wherein the logic to dynamically adjust the strength
20 of the ECC of the block of data is to:

select one of the plurality of code words;
perform an exclusive OR (XOR) operation on all the code words except the selected code word to obtain a XOR code word; and
replace the selected code word with the XOR code word.

25 10. The apparatus of claim 1, wherein the apparatus is a NAND flash memory solid-state drive (SSD) controller.

11. The apparatus of claim 1, where the apparatus is compliant at least in part with an Open NAND Flash Interface (ONFI) protocol.

12. An apparatus comprising:
30 one or more memory modules; and
a controller coupled to the one or more memory modules to dynamically adjust a strength of an Error Correcting Code (ECC) of data to be stored in the one or memory modules.

13. The apparatus of claim 12, wherein the controller to dynamically adjust the strength of the ECC of the data to be stored in the one or more memory modules is to dynamically adjust the strength of the ECC of the data to be stored in the one or memory modules based on at least one of a Bit Error Rate (BER) associated
5 with a location in the one or more memory modules that is to store the data and an erase count of a physical band of the one or more memory modules that is to store the data.

14. The apparatus of claim 12, wherein the data is to be partitioned into one or more data chunks to be stored in a memory page of the one or more memory
10 modules, and wherein the controller to dynamically adjust the strength of the ECC of the data to be stored in the one or memory modules is to:

select one of the one or more data chunks;

perform an exclusive OR (XOR) operation on all data chunks except the selected data chunks to obtain a XOR data chunk; and

15 replace the selected data chunk with the XOR data chunk to be stored in the memory page of the one or more memory modules.

15. The apparatus of claim 14, wherein each data chunk comprises lossless compressed data.

16. The apparatus of claim 12, wherein the controller is further to:

20 compress the data;

determine whether the data is compressed below a threshold; and

write the compressed block of data into the one or more memory modules in response to a determination that the block of data is compressed below the threshold, wherein the threshold is based on at least one of a size of the
25 compressed data, and a compression ratio of a size of the data to a size of the compressed data.

17. The apparatus of claim 16, wherein the controller to dynamically adjust the strength of the ECC of the data to be stored in the one or memory modules is to:

add a known data pad to the compressed data;

30 determine ECC check bytes of the compressed data and the known data pad; and

add the determined ECC check bytes to the compressed data and the known data pad.

18. The apparatus of claim 16, wherein the compressed data is to be partitioned into one or more data chunks and wherein the controller to dynamically adjust the strength of the ECC of the data to be stored in the one or memory modules is to:

5 determine a respective one of one or more ECC check bytes for each of the one or more data chunks; and

add the determined respective one ECC check bytes to each of the one or more data chunks.

19. The apparatus of claim 16, wherein the compressed data is to be

10 partitioned into one or more data chunks and wherein the controller to dynamically adjust the strength of the ECC of the data to be stored in the one or memory modules is to:

add a respective one of one or more known data pads to each of the one or more data chunks;

15 determine a respective one of one or more ECC check bytes of each of the one or more data chunks and each respective one of the one or more known data pads; and

add the determined respective one ECC check bytes to each data chunk and the respective one known data pad.

20 20. The apparatus of claim 12, wherein the apparatus is a NAND flash memory solid-state drive (SSD).

21. A method comprising:

selecting one of a plurality of code words to be stored in a memory page of a memory module;

25 executing an exclusive OR (XOR) operation on all the code words except the selected code word to obtain a XOR code word; and

replacing the selected code word with the XOR code word to be stored in the memory page of the memory module.

22. The method of claim 21, wherein the selected code word is a last code word to be stored in the memory page of the memory module.

30 23. The method of claim 21, further comprising:

dynamically adjusting a strength of an Error Correcting Code (ECC) of the plurality of code words to be stored in the memory module based on at least one

of a Bit Error Rate (BER) associated with a location in the memory module that is to store the data and an erase count of a physical band of the memory module that is to store the data.

24. The method of claim 21, wherein dynamically adjusting the strength of the
5 ECC of the plurality of code words to be stored in the memory module comprises:
compressing each code word; and
determining whether each code word is compressed below a threshold,
wherein the threshold is based on at least one of a size of the compressed code
word, and a ratio of a size of each code word to a size of each compressed code
10 word.

25. The method of claim 24, wherein dynamically adjusting the strength of the
ECC of the plurality of code words to be stored in the memory module comprises:
determining a respective ECC check bytes of each of compressed code
word; and
15 adding the determined respective ECC check bytes to each compressed
code word.

26. The method of claim 24, wherein dynamically adjusting the strength of the
ECC of the plurality of code words to be stored in the memory module comprises:
adding a respective one of a plurality of known data pads to each
20 compressed code word;
determining a respective one of a plurality of ECC check bytes for each
compressed code word and the respective one known data pad; and
add the determined respective one ECC check bytes to each compressed
code word and each respective one known data pad.

27. The method of claim 26, wherein a combined size of each known data pad
and each compressed codeword is to match a size of each codeword.

1/6

110
NAND page

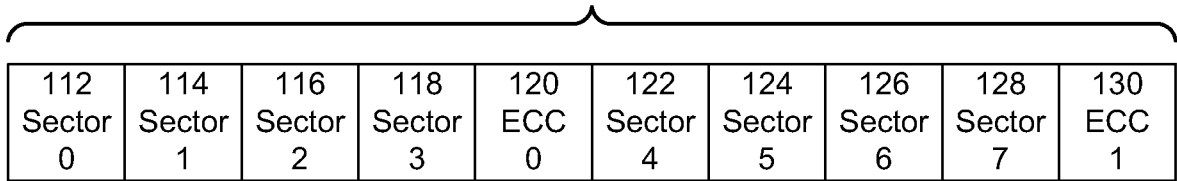

100

(PRIOR ART)
FIG. 1A

160
NAND page

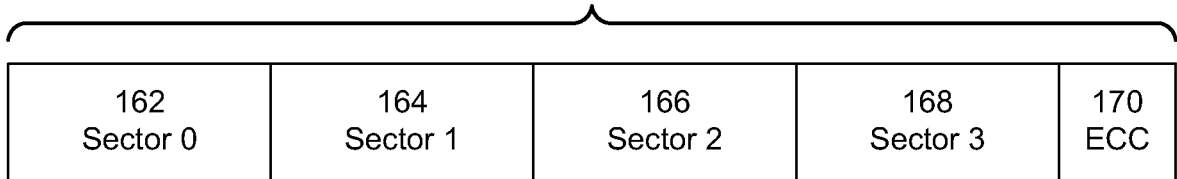

150

(PRIOR ART)
FIG. 1B

190
NAND page

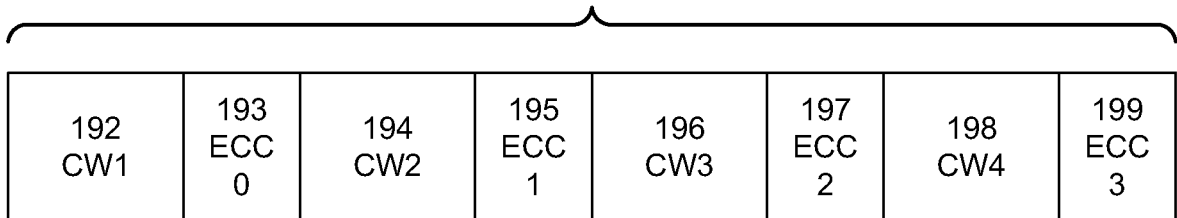

180

(PRIOR ART)
FIG. 1C

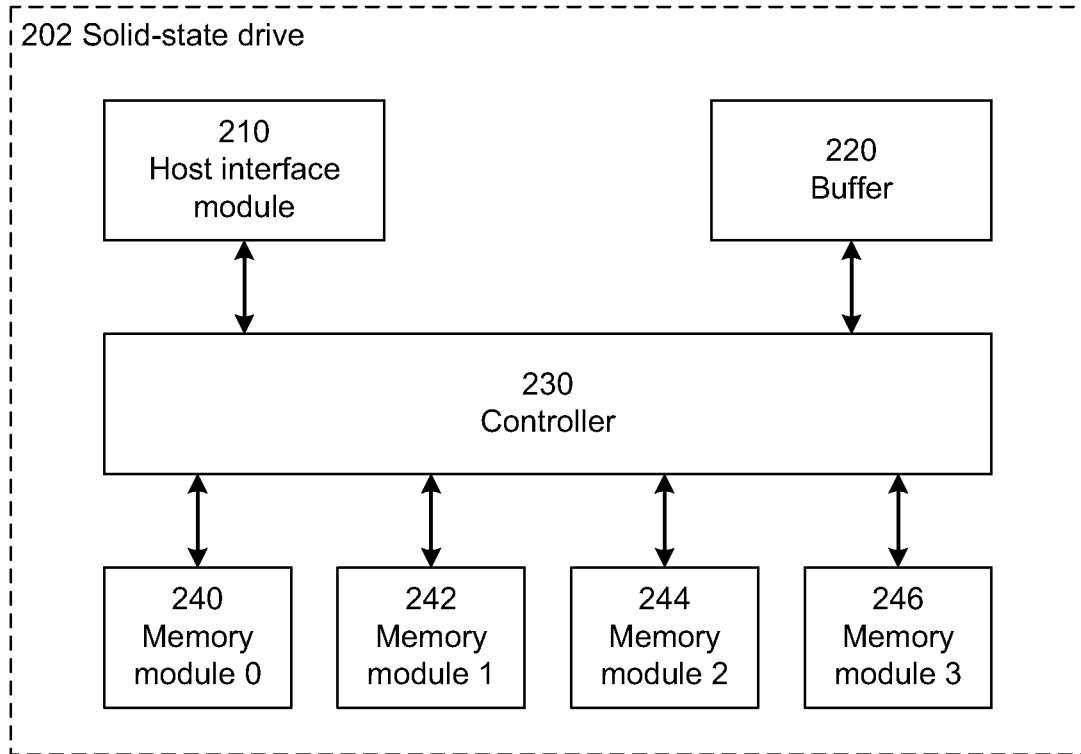

200

FIG. 2

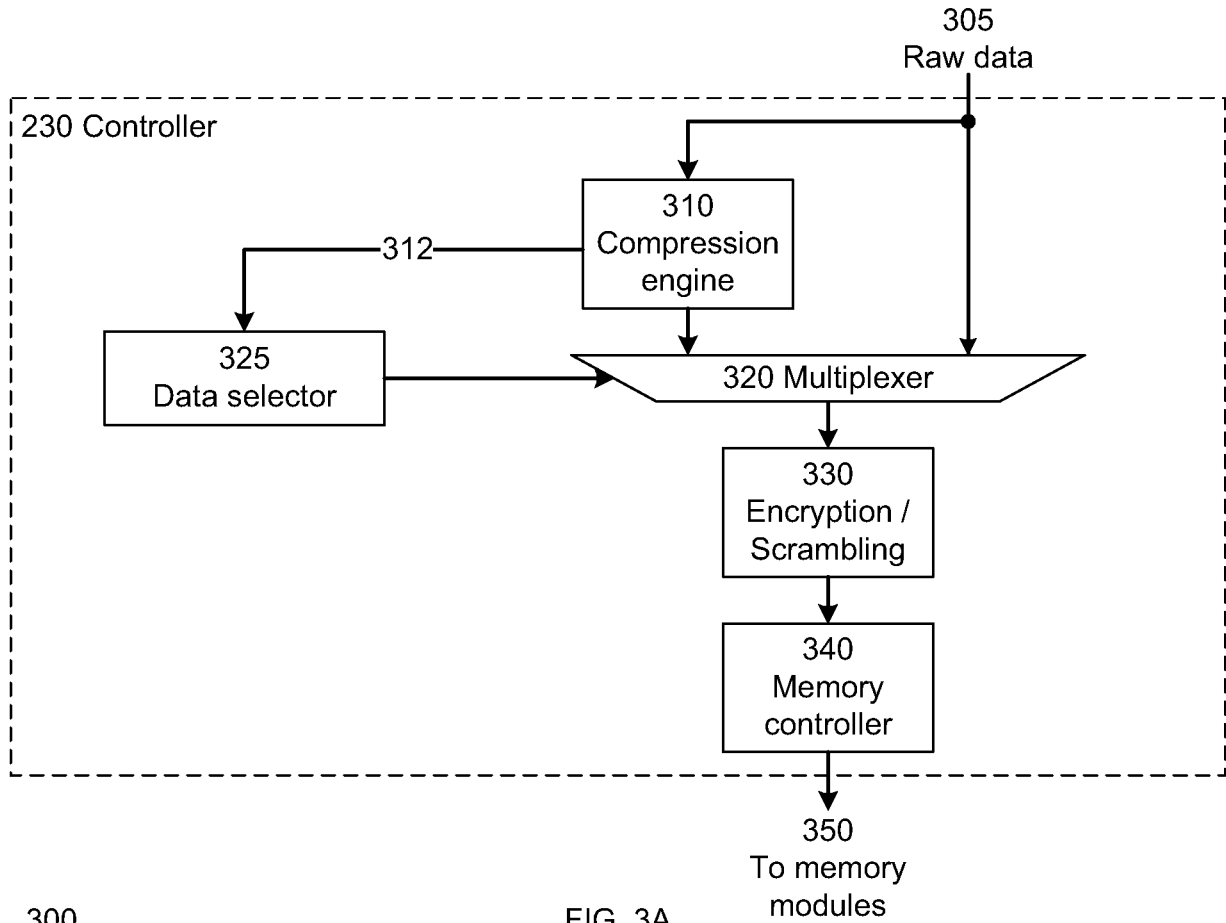

300

FIG. 3A

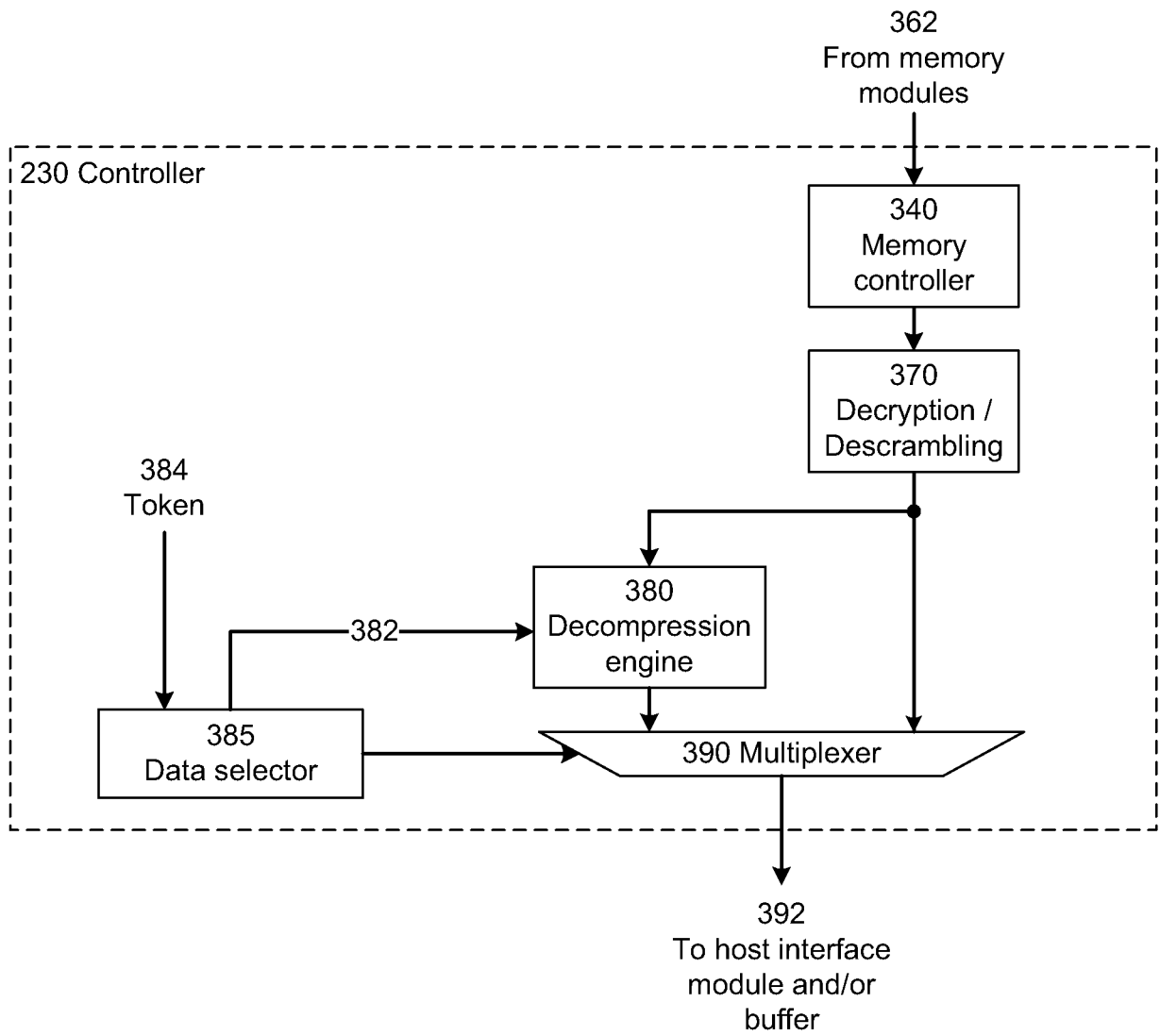

360

FIG. 3B

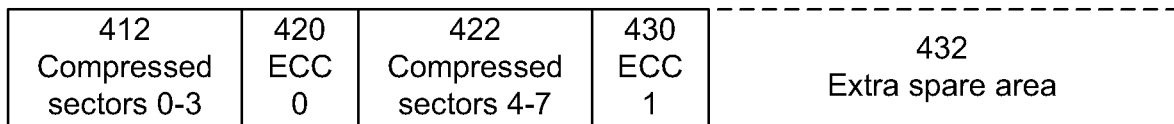

400

FIG. 4

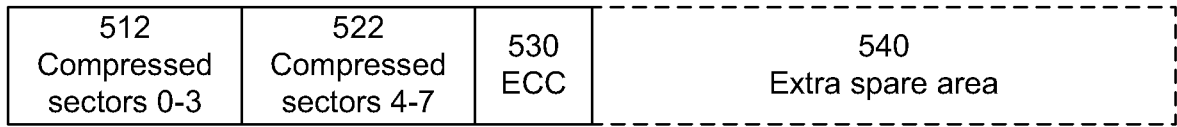

500

FIG. 5

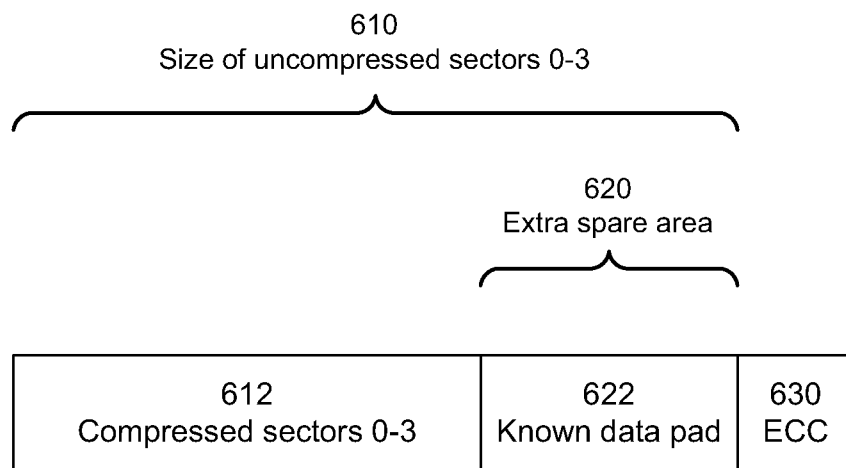

600

FIG. 6

5/6

710
NAND page

712 Compressed sectors 0-3 (2X CW1)	720 ECC 0	722 Compressed sectors 0-3 (2X CW2)	730 ECC 1
---	-----------------	---	-----------------

760
NAND page

772 Compr. sec. 0-3 (1X CW1)	780 ECC 0	774 Compr. sec. 0-3 (1X CW2)	782 ECC 1	776 Compr. sec. 0-3 (1X CW3)	784 ECC 2	778 Compr. sec. 0-3 (1X CW4)	786 ECC 3
---------------------------------------	-----------------	---------------------------------------	-----------------	---------------------------------------	-----------------	---------------------------------------	-----------------

700

FIG. 7

810
NAND page

812 Compressed sectors 0-3 (2X CW1)	814 Known data pad	820 ECC 0	822 Compressed sectors 0-3 (2X CW2)	824 Known data pad	830 ECC 1
---	--------------------------	-----------------	---	--------------------------	-----------------

800

FIG. 8

910
NAND page

192 CW1	193 ECC 0	194 CW2	195 ECC 1	196 CW3	197 ECC 2	920 XOR of CW1 to CW3	926 ECC 3
------------	-----------------	------------	-----------------	------------	-----------------	--------------------------------	-----------------

900

FIG. 9

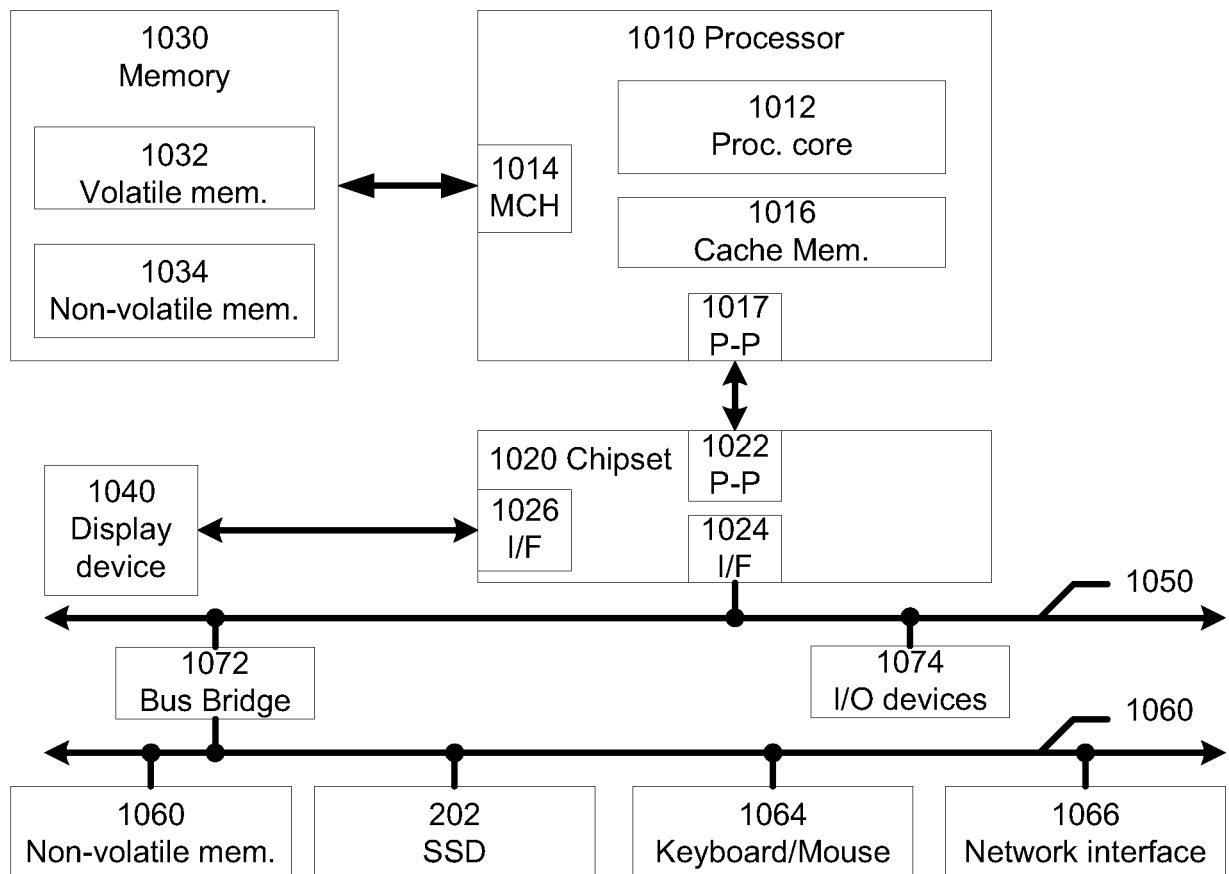

1000

FIG. 10